

# Instruktionsmanual Instruction Manual Gebrauchsanweisung

Spejl T5 / Mirror T5 / Spiegel T5  
T5 2x13W - 230V~50Hz

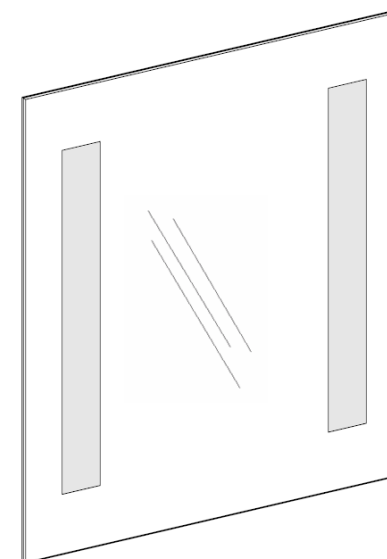
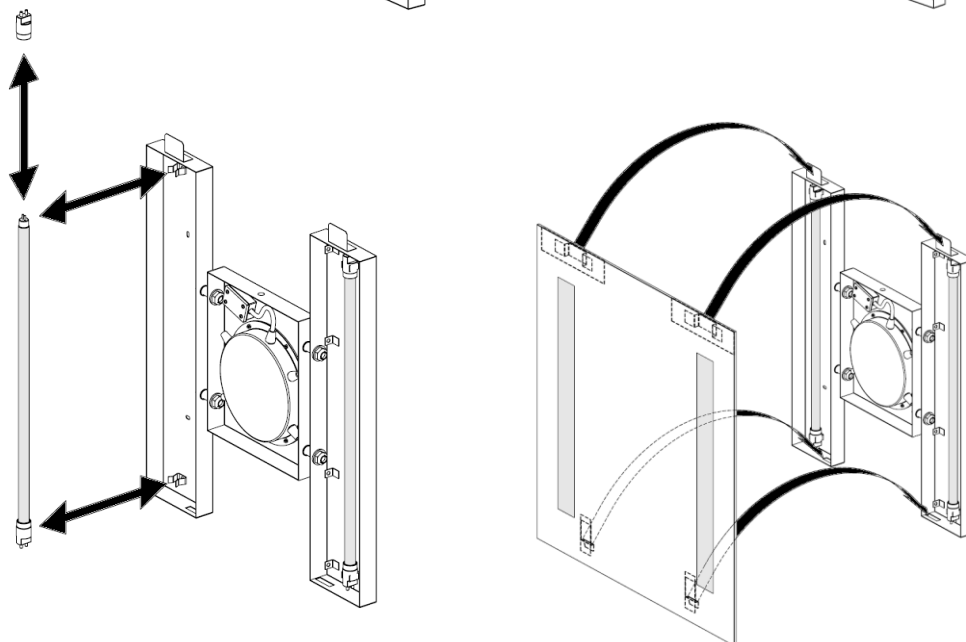

[DK]Strømmen skal afbrydes, før udskiftning af røret. Skift venligst begge rør, for at undgå farveforskel.

[GB]The power must be turned off before replacing the tube. Please replace both tubes, to avoid colour-difference.

[D]Die Stromversorgung muss nicht eingeschaltet sein, bevor das Rohr ersetzt wird. Wechseln Sie bitte beide Rohre, um Farbeunterschied zu vermeiden.

**60x65 cm**

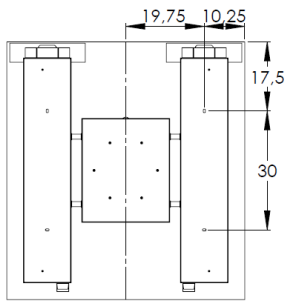

**100x65 cm**

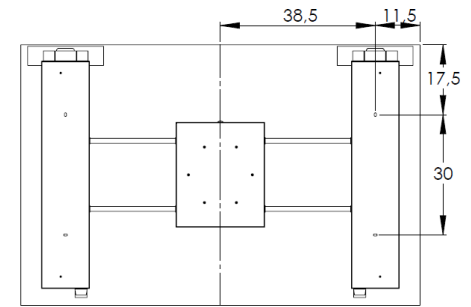

**70x65 cm**

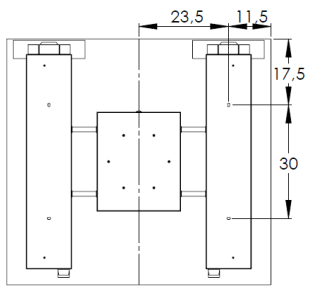

**120x65 cm**

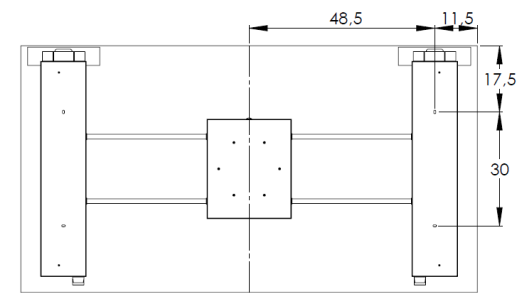

**80x65 cm**

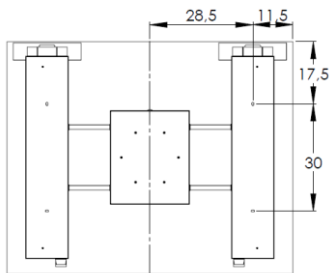

**160x65 cm**

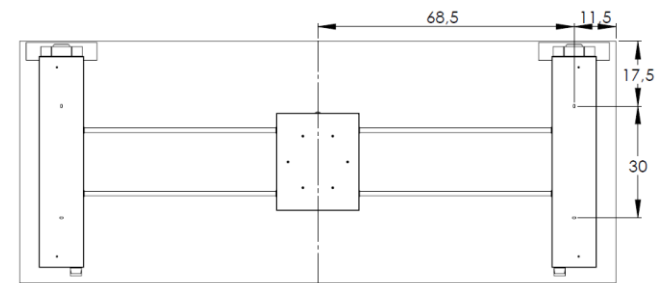

**90x65 cm**

